

REVISIONS			
ZONE	REV	FINISHES:	GAUGE:
		626	7ga. .180

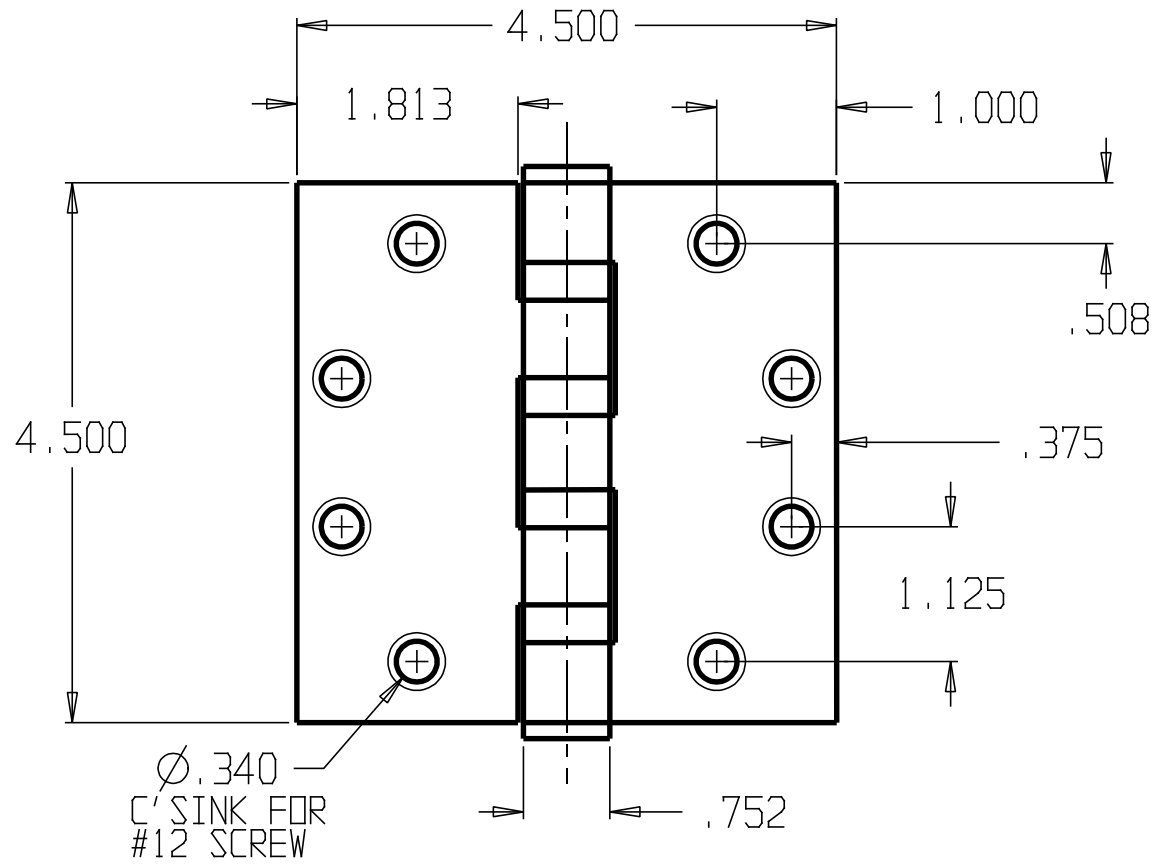

DON-JO MFG. INC.				SIZE	DATE:	PART NO.	REV
DESIGNER		A	1/14/05	HWBB-84545			
APPROVED		SCALE	RELEASE DATE	WEIGHT	SHEET		