

REVISIONS				
ZONE	REV	FINISHES:	DATE	APPROVED
		630		

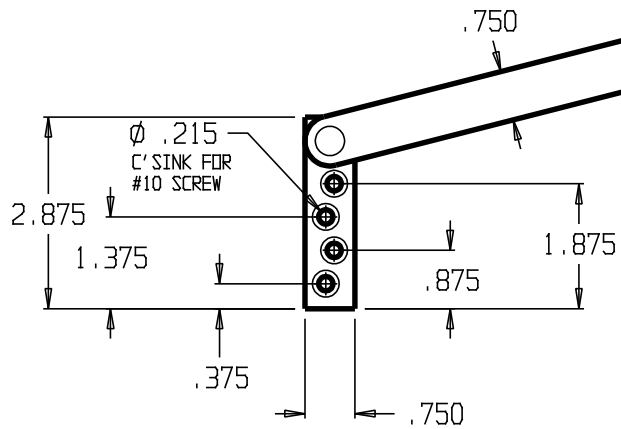
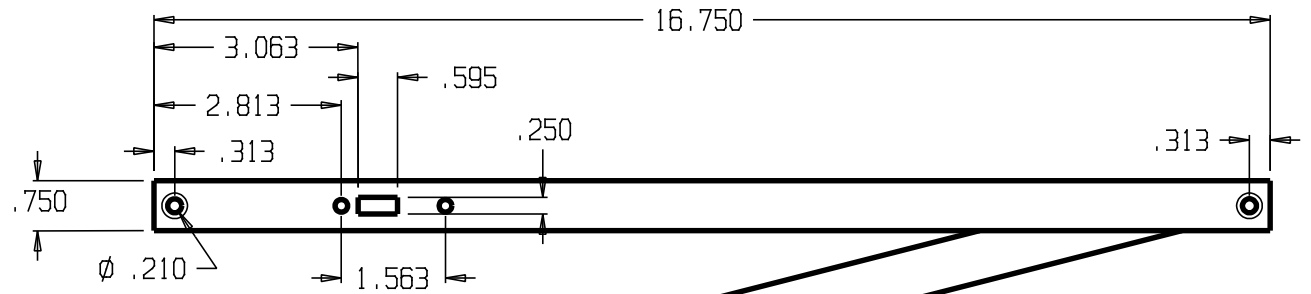

DON-JO MFG. INC.

DESIGNER	SIZE	DATE:	PART NO.	REV
	A	4/21/04	#3024	
APPROVED	SCALE	RELEASE DATE	WEIGHT	SHEET