

REVISIONS				
ZONE	REV	FINISHES:	DATE	APPROVED
		605,613,626		

Ø .195  
C' SINK FOR  
#8 SCREW

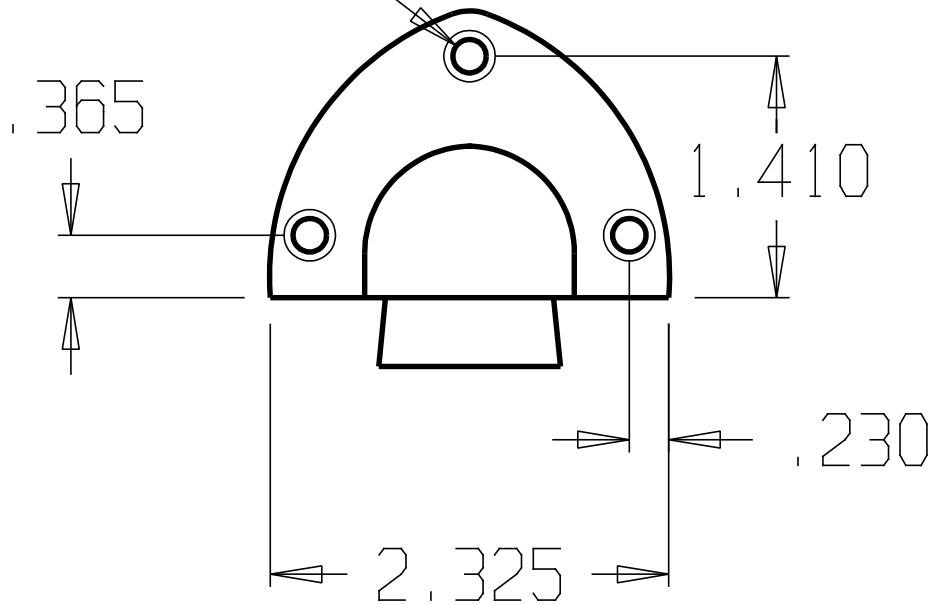
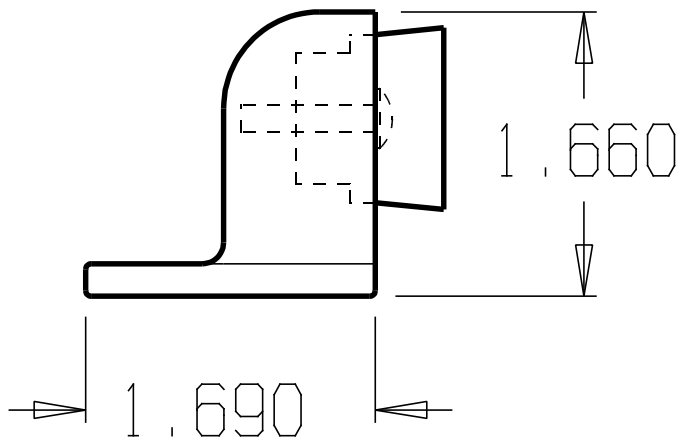

DON-JO MFG. INC.

DESIGNER	SIZE A	DATE: 3/11/04	PART NO. #1448	REV
APPROVED	SCALE	RELEASE DATE	WEIGHT	SHEET