

REVISIONS				
ZONE	REV	FINISHES:	DATE	APPROVED
		630		

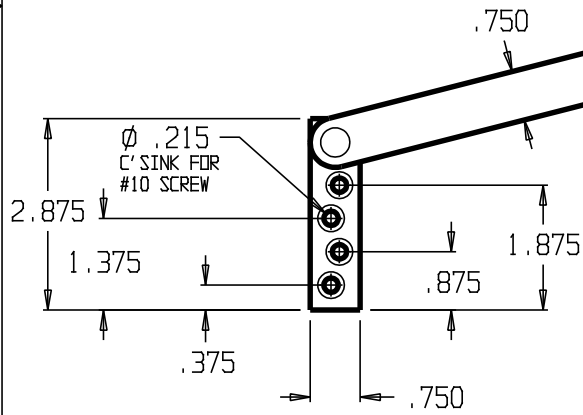
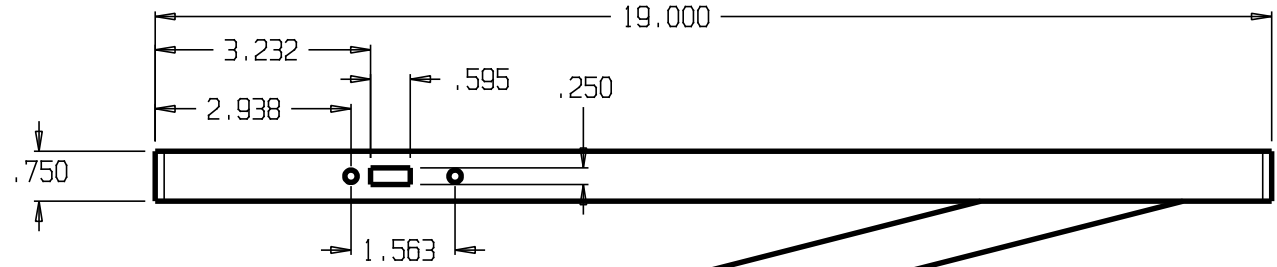

DON-JO MFG. INC.

DESIGNER	SIZE A	DATE: 4/21/04	PART NO. #3124	REV
APPROVED	SCALE	RELEASE DATE	WEIGHT	SHEET