

REVISIONS				
ZONE	REV	FINISHES:	DATE	APPROVED
		605,613,628,630		

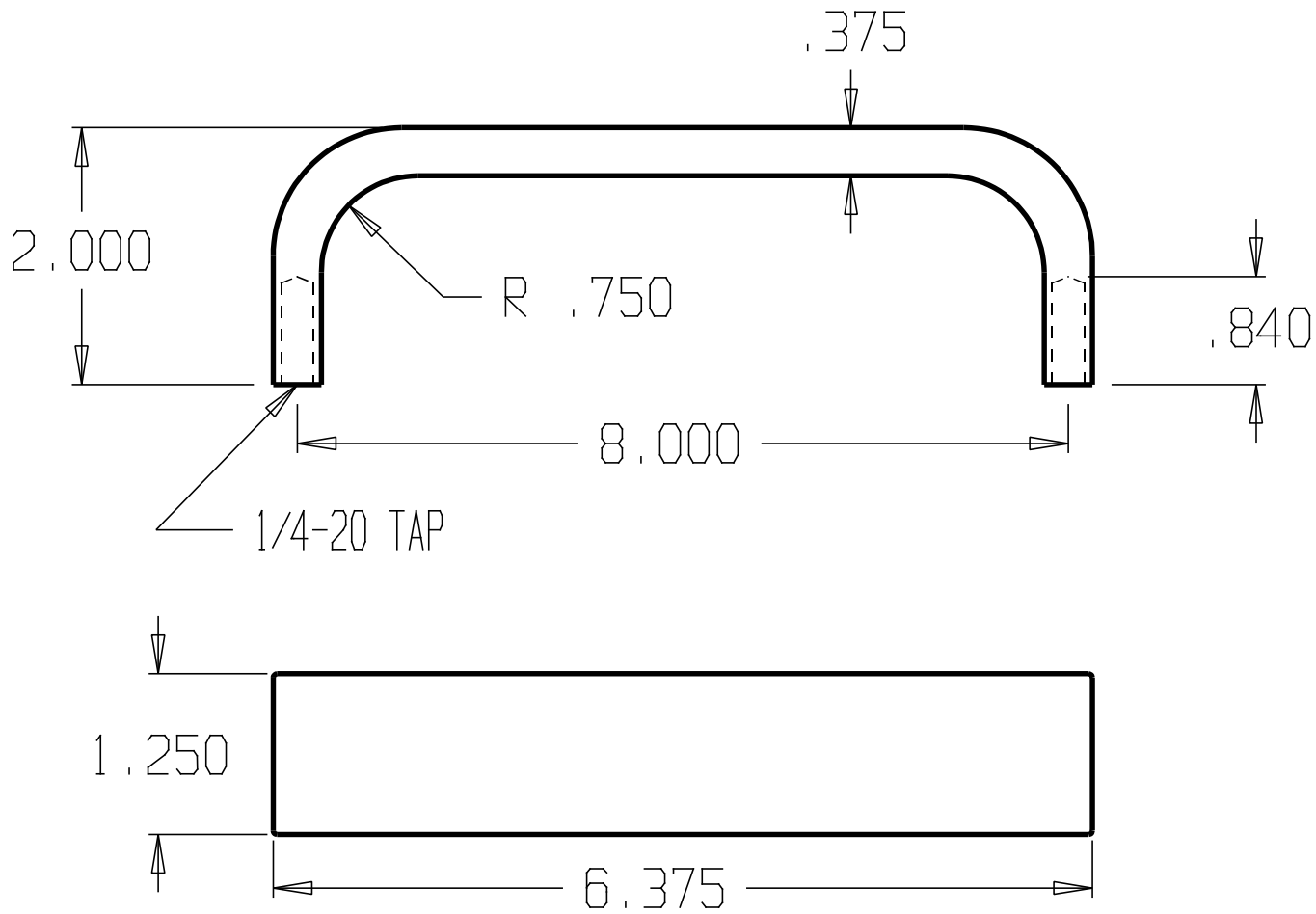

DON-JO MFG. INC.

DESIGNER		SIZE	A	DATE:	4/19/04	PART NO.	#31	REV	
APPROVED		SCALE		RELEASE DATE		WEIGHT		SHEET	