

REVISIONS				
ZONE	REV	FINISHES:	DATE	APPROVED
		605,613,628,630		

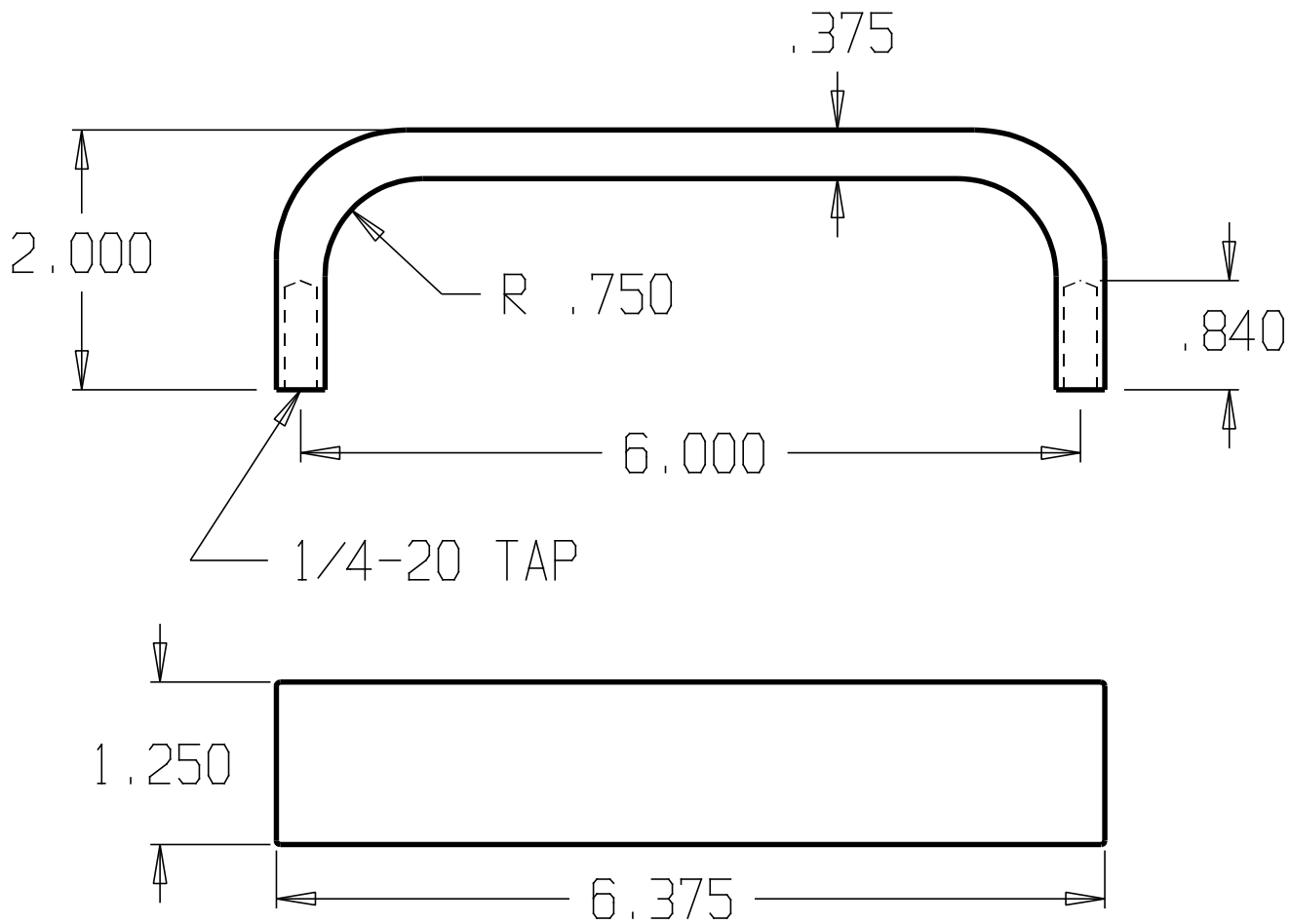

**DON-JO MFG. INC.**

DESIGNER	
APPROVED	

SIZE	DATE:	PART NO.	REV
A	4/19/04	#30	
SCALE	RELEASE DATE	WEIGHT	SHEET